

Actuator and Sensor Cable, PUR Quick-turn Connection Cable WKC4Q-5/TXL

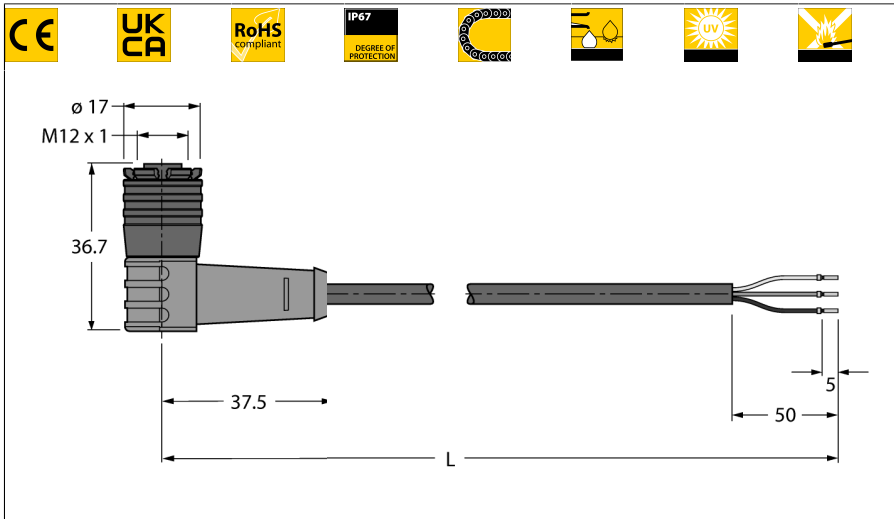

- Female M12, angled, 3-pin
- Sheath material: PUR
- Sheath color: black
- Qualified for drag chain use
- Resistant to weld splatter
- Resistant to chemicals, UV radiation and oils
- Flame retardant
- Free from halogen, silicone, PVC and LABS
- Particularly resistant to abrasion
- RoHS conform
- Protection class IP67
- Cable length: 5.0 m

Type	WKC4Q-5/TXL
ID	6628014

Connector A	Female, M12 × 1, Angled, A-coded
Number of pins	3
Contact carriers	Plastic, TPU, Black
Connector body	Plastic, TPU, Yellow
Interlocking sleeve	Plastic, PBT, black
Mechanical lifespan	> 50 Mating cycles
Pollution degree	3
Protection class	IP67, (plugged)

Cable	
Cable diameter	Ø 4.1mm ±0.20
Cable length	5 m m
Cable jacket	PUR, Black
Core insulation	PP
Core cross-section	3 x 0.34 mm ²
Arrangement of strands	42 x 0.1mm
Core colors	BN, BU, BK

Electrical properties at +20 °C	
Rated voltage	250V
Test voltage	2000 V
Current	4AA
Insulation resistance	> 30.5 MΩ/km
forward resistance	max. 57 Ω/km

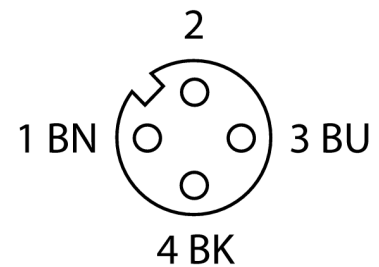

Circuit Diagram

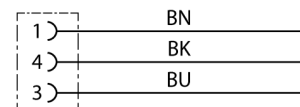

Mechanical and chemical properties	
Bending radius (stationary installation)	$\geq 5 \times \varnothing$
Bending radius (flexible use)	$\geq 10 \times \varnothing$
Bending cycles	≥ 5 million
Admissible acceleration	max. 5 m/s ²
Admissible travel path, horizontal	5 m (at 5 m/s ²)
Admissible travel path, vertical	2 m (at 5 m/s ²)
Admissible traversing speed	3.3 m/s
Torsional stress	± 180 °/m
Ambient temperature (fixed)	-50...+80°C
Ambient temperature (mobile)	-25...+80°C
Ambient temperature (drag chain)	-25...+60°C

Accessories

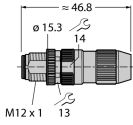
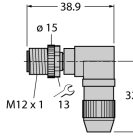
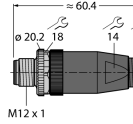
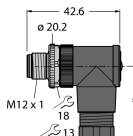
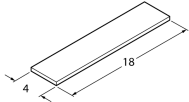
Type code	Ident no.		Dimension drawing
HAS8141-0	6905406	Field-wireable male connector, M12 × 1, straight, 4-pin, insulation piercing connection, cable feedthrough 4.0 to 5.1 mm, core cross-section/terminal capacity 0.14 to 0.34 mm ² , plastic housing, metal nut	 <p>Technical drawing of the HAS8141-0 connector showing dimensions: total length ≈ 46.8 mm, diameter ø 15.3 mm, and terminal spacing 14 mm and 13 mm. The connector is labeled M12 x 1.</p>
HAS8241-0	6905400	Field-wireable male connector, M12 × 1, angled, 4-pin, insulation piercing connection, cable feedthrough 4.0 to 5.1 mm, core cross-section/terminal capacity 0.14 to 0.34 mm ² , plastic housing, metal nut	 <p>Technical drawing of the HAS8241-0 angled connector showing dimensions: total length 38.9 mm, diameter ø 15 mm, and terminal spacing 13 mm and 13 mm. The connector is labeled M12 x 1.</p>
BS8141-0	69010	Field-wireable male connector, M12 × 1, straight, 4-pin, screw terminal connection, cable feedthrough 4.0 to 6.0 mm, core cross-section/terminal capacity 0.14 to 0.75 mm ² , plastic housing, metal retaining screw	 <p>Technical drawing of the BS8141-0 screw terminal connector showing dimensions: total length ≈ 60.4 mm, diameter ø 20.2 mm, and terminal spacing 18 mm, 14 mm, and 13 mm. The connector is labeled M12 x 1.</p>
BS8241-0	69011	Field-wireable connector, M12 × 1, angled, 4-pin, screw terminal connection, cable feedthrough 4.0 to 6.0 mm, core cross-section/terminal capacity 0.14 to 0.75 mm ² , plastic housing, metal retaining screw	 <p>Technical drawing of the BS8241-0 angled screw terminal connector showing dimensions: total length 42.6 mm, diameter ø 20.2 mm, and terminal spacing 18 mm, 13 mm, and 13 mm. The connector is labeled M12 x 1.</p>
BLANK-LABEL-FOR-CORDSETS-TEL-TXL	6936206	Label for TEL and TXL cables, length: 18 mm, height: 4 mm, material: polycarbonate (PC), color: white, halogen-free and flame-retardant	 <p>Technical drawing of the label showing dimensions: length 18 mm and height 4 mm.</p>