

SLPCP14-830P88

Personnel Safety, Light Screen – Emitter/Receiver Pair

Cascadable

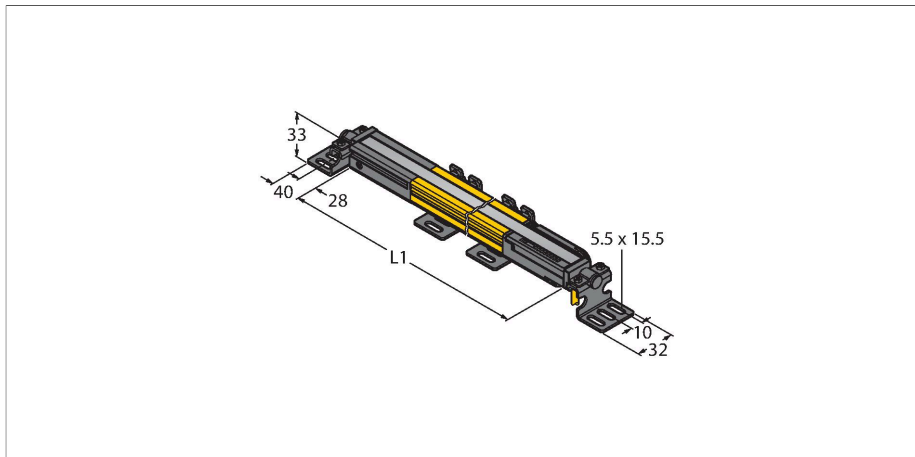

Technical data

| | |
|--------------------------------------|-----------------------------------|
| Type | SLPCP14-830P88 |
| ID | 3083751 |
| Optical data | |
| Function | Light screen |
| Light type | IR |
| Wavelength | 850 nm |
| Optical resolution | 14 mm |
| Range | 100...7000 mm |
| Scan field | 830 mm |
| Number of beams | 83 |
| With muting function | no |
| Scan Code | Adjustable |
| Electrical data | |
| Operating voltage | 20...28 VDC |
| Residual ripple | < 10 % U_{ss} |
| DC rated operational current | ≤ 210 mA |
| No-load current | ≤ 275 mA |
| Max. current safe output | 500 mA |
| Short-circuit protection | yes |
| Reverse polarity protection | yes |
| Output function | 2 x NC (normally closed), 2 x PNP |
| Number of safe semiconductor outputs | 2 |
| Response time typical | < 22.5 ms |
| With restart interlock | yes |
| Blanking function | yes |

Features

- Cable with male end M12 × 1, 8-pin, 300 mm
- Connection to cascadable nodes via DEE2R-8...
- Protection class IP65
- Flat housing without blind zone
- Adjustment via DIP switch
- Resolution can be reduced
- Blanking function
- Operating voltage: 24 VDC ± 15 %
- Resolution 14 mm
- Scan field 830 mm (L1)
- Personnel safety Cat 4, PL e acc. to EN ISO 13849-1:2008
- Type 4 according to IEC 61496-1,-2
- SIL 3 to IEC 61508

Wiring diagram

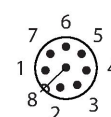
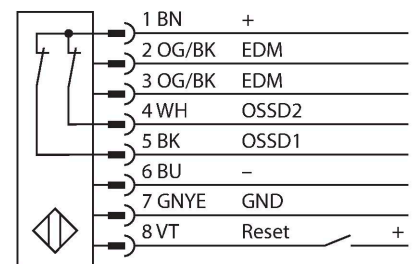

Technical data

| Mechanical data | |
|-----------------------|----------------------------------------------------------------------|
| Design | Rectangular, EZ-Screen LP |
| Dimensions | 26 x 28 x 829 mm |
| Housing material | Metal, AL, Yellow polyester |
| Lens | plastic, Acrylic |
| Cascadable | Yes |
| Electrical connection | Cable with connector, M12 × 1, 300 m |
| Number of cores | 8 |
| Ambient temperature | 0...+55 °C |
| Protection class | IP65 |
| Power-on indication | LED, Green |
| Switching state | 2-color LED, Red |
| Tests/approvals | |
| Vibration resistance | 10-55 Hz at 0.35 mm |
| Shock test | 10 g at 16 ms (6000 cycles) |
| Approvals | CE, cTUVus, PL e acc. to ENISO 13849-1:2008, SIL 3 acc. to IEC 61508 |





Functional principle

The high-resolution safety light curtain is emitter and receiver in one without blind zone. As the system is synchronized optically, wiring between emitter and receiver is redundant. The safety switching outputs of the receiver are directly connected to a load relay (e.g. IM-TA9A) and trigger an immediate stop of the dangerous machine cycle. The switching device with 2-channel monitoring, diverse redundant designed and mutual processor control, complies with the personnel safety category PLe acc. to ISO 13849-1.

Accessories

| | | | | | |
|-------------|---------|---------------------------------------------------------------------------------------------------------------------------------------------------------------------------|-------------|---------|--------------------------------------------------------------------------------------------------------------------------------------------------------------|
| LPA-MBK-11 | 3082841 | Mounting bracket, retainer for closure caps, 14-ga. steel, galvanized, black, 360 ° sensor rotation, incl.2 pcs. with screw set | LPA-MBK-12 | 3082842 | Mounting bracket, side mounting, 14-ga. steel, galvanized, black, +10°/-30° sensor rotation, incl.1 pcs. with screw set |
| LPA-MBK-20 | 3082853 | Mounting bracket, wall mounting, 12-ga. steel, galvanized, black, in combination with LPA-MBK-11/ -12/ -13, incl. 1 pcs. and screw set | LPA-MBK-22 | 3082844 | Mounting bracket, wall mounting, 14-ga. steel, galvanized, black, in combination with LPA-MBK-11, incl. 2 pcs. and screw set |
| LPA-MBK-21 | 3082845 | Mounting bracket, side mounting, 14-ga. steel, galvanized, black, +10°/-30° sensor rotation, for mounting of cascadable EZ-Screen LP, adjustable orientation 90° to 180 ° | LPA-MBK-90 | 3082846 | Mounting bracket, side mounting, 14-ga. steel, galvanized, black, +10°/-30° sensor rotation, for mounting of cascadable EZ-Screen LP, firm orientation 90 ° |
| LPA-MBK-120 | 3082847 | Mounting bracket, side mounting, 14-ga. steel, galvanized, black, +10°/-30° sensor rotation, for mounting of cascadable EZ-Screen LP, firm orientation 120° | LPA-MBK-135 | 3082848 | Mounting bracket, side mounting, 14-ga. steel, galvanized, black, +10°/-30° sensor rotation, for mounting of cascadable EZ-Screen LP, firm orientation 135 ° |
| LPA-MBK-180 | 3082849 | Mounting bracket, side mounting, 14-ga. steel, galvanized, black, +10°/-30° sensor rotation, for mounting of cascadable EZ-Screen LP, firm orientation 180 ° | | | |

Accessories

| Dimension drawing | Type | ID | |
|-------------------------------------------------------------------------------------|-----------------|---------|----------------------------------------------------------------------------------------------------------------------------|
| | DEE2R-81D | 3072205 | Connection cable, PVC, yellow, length: 0.31 m, female M12 x 1 - male M12, 8-pin |
| | DEE2R-83D | 3072206 | Connection cable, PVC, yellow, length: 0.91 m, female M12 x 1 - male M12, 8-pin |
| | DEE2R-88D_ | 3072635 | Connection cable, PVC, yellow, length: 2.44 m, female M12 x 1 - male M12, 8-pin |
| | DEE2R-815D | 3072207 | Connection cable, PVC, yellow, length: 4.57 m, female M12 x 1 - male M12, 8-pin |
| | DEE2R-825D | 3072208 | Connection cable, PVC, yellow, length: 7.62 m, female M12 x 1 - male M12, 8-pin |
| | DEE2R-850D | 3072209 | Connection cable, PVC, yellow, length: 15.2 m, female M12 x 1 - male M12, 8-pin |
| | DEE2R-875D | 3072210 | Connection cable, PVC, yellow, length: 22.9 m, female M12 x 1 - male M12, 8-pin |
| | DEE2R-8100D | 3072211 | Connection cable, PVC, yellow, length: 30.5 m, female M12 x 1 - male M12, 8-pin |
|  | QDE-815D | 3070883 | Connection cable for safety light screens, PVC, yellow, length 4.57 m, female connection, M12 x 1, 8-pin |
|  | QDE-825D | 3070884 | Connection cable for safety light screens, PVC, yellow, length 7.62 m, female connection, M12 x 1, 8-pin |
|  | QDE-850D | 3070885 | Connection cable for safety light screens, PVC, yellow, length 15.3 m, female connection, M12 x 1, 8-pin |
|  | QDE-875D | 3071466 | Connection cable for safety light screens, PVC, yellow, length 22.9 m, female connection, M12 x 1, 8-pin |
|  | QDE-8100D | 3071467 | Connection cable for safety light screens, PVC, yellow, length 30.5 m, female connection, M12 x 1, 8-pin |
| | CSB-M1280M1280 | 3075375 | Y-piece, PVC, yellow, with male M12 x 1, 8-pin on 2 x 0.3 m cable, PVC, yellow, with female M12 x 1, 8-pin |
| | CSB-M1281M1281 | 3073252 | Y-piece, PVC, yellow, length: 0.3 m with male, M12 x 1, 8-pin on 2 x 0.3 m cable, PVC, yellow, with female, M12 x 1, 8-pin |
| | CSB-M1288M1281 | 3073253 | Y-piece, PVC, yellow, length: 2.5 m with male, M12 x 1, 8-pin on 2 x 0.3 m cable, PVC, yellow, with female, M12 x 1, 8-pin |
| | CSB-M12815M1281 | 3073254 | Y-piece, PVC, yellow, length: 4.6 m with male, M12 x 1, 8-pin on 2 x 0.3 m cable, PVC, yellow, with female, M12 x 1, 8-pin |

| Dimension drawing | Type | ID | |
|-------------------|-----------------|---------|----------------------------------------------------------------------------------------------------------------------------|
| | CSB-M12825M1281 | 3073255 | Y-piece, PVC, yellow, length: 7.6 m with male, M12 x 1, 8-pin on 2 x 0.3 m cable, PVC, yellow, with female, M12 x 1, 8-pin |
| | DEE2R-88D | 3094306 | Connection cable, PVC, yellow, length: 2.44 m, M12 x 1 female connector, 8-pin, on M12 x 1 male connector, 8-pin |