

Q40RW3FF400Q1

Photoelectric Sensor – Diffuse Mode Sensor with Fixed-Field Background Suppression

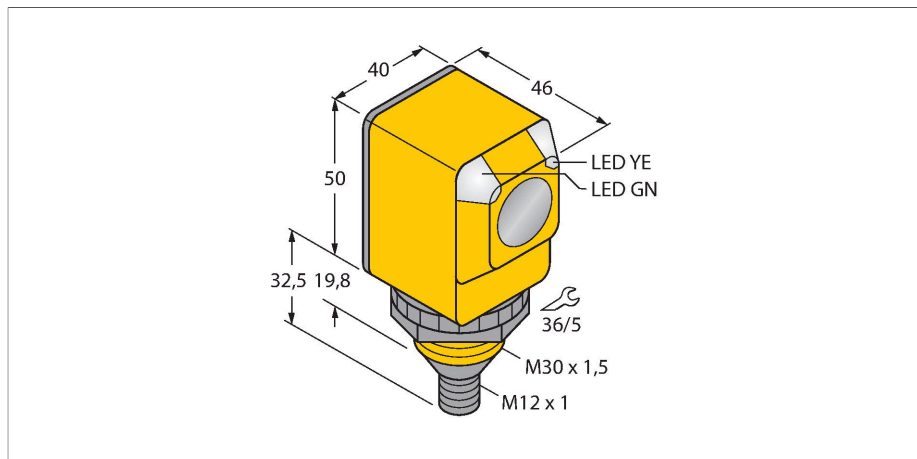

Features

- M12 × 1 Micro male connector (AC), 4-pin
- Protection classes IP67/IP69K
- Ambient temperature: -40 °C...+70 °C

Wiring diagram

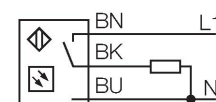

Functional principle

The emitter and receiver are incorporated in a single housing. The light reflection of the target is detected and triggers the sensor to switch. Thus the switching distance largely depends on the reflectivity of the target.

Excess gain curve

Excess gain in relation to the distance

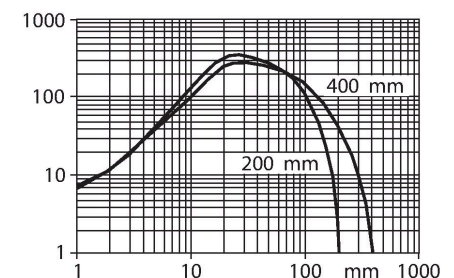

Technical data

| | |
|------------------------------|--|
| Type | Q40RW3FF400Q1 |
| ID | 3033389 |
| Optical data | |
| Function | Proximity switch |
| Operating mode | Background suppression, non-adjustable |
| Light type | IR |
| Wavelength | 880 nm |
| Range | 0...400 mm |
| Electrical data | |
| Operating voltage | 20...250 VAC |
| AC rated operational current | ≤ 200 mA |
| Output function | Dark operation, Relay output |
| Switching frequency | ≤ 40 Hz |
| Readiness delay | ≤ 100 ms |
| Response time typical | < 16 ms |
| Mechanical data | |
| Design | Rectangular, Q40 |
| Dimensions | Ø 30 x 46 x 40.1 x 82.5 mm |
| Housing material | Plastic, Thermoplastic material |
| Lens | plastic, Polycarbonate |
| Electrical connection | Connector, 1/2", PVC |
| Number of cores | 4 |
| Ambient temperature | -40...+70 °C |
| Protection class | IP69 |
| Special features | Encapsulated Wash down |

Technical data

| | |
|------------------------|---|
| Power-on indication | LED, Green |
| Switching state | LED, Yellow |
| Excess gain indication | LED |
| Tests/approvals | |
| MTTF | 448 years acc. to SN 29500 (Ed. 99) 40 °C |
| Approvals | CE, UL, CSA |

Accessories

SMB30A

3032723

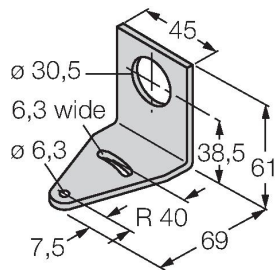

Mounting bracket, rectangular, stainless steel, for sensors with 30mm thread

SMB30FAM10

3011185

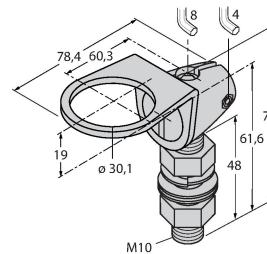

Mounting bracket, stainless steel, for M10 x 1.5 thread, thread length 30 mm

SMB30SC

3052521

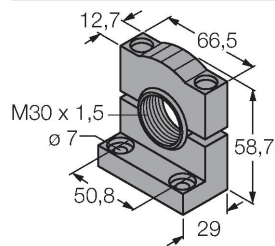

Mounting bracket, PBT black, for sensors with 30 mm thread, rotatable

SMBAMS30P

3073135

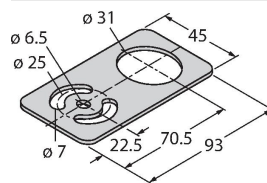

Mounting bracket, stainless steel, for sensors with 30 mm thread